



DEMONSTRATED LEADERSHIP IN ELECTRIFICATION DESIGN

2019 NESEA BuildingEnergy NYC

September 26, 2019

Jason Lukes, LEED AP
Associate Principal

Jacob Knowles, LEED AP
Associate Principal | Director of Sustainable Design

LEGACY

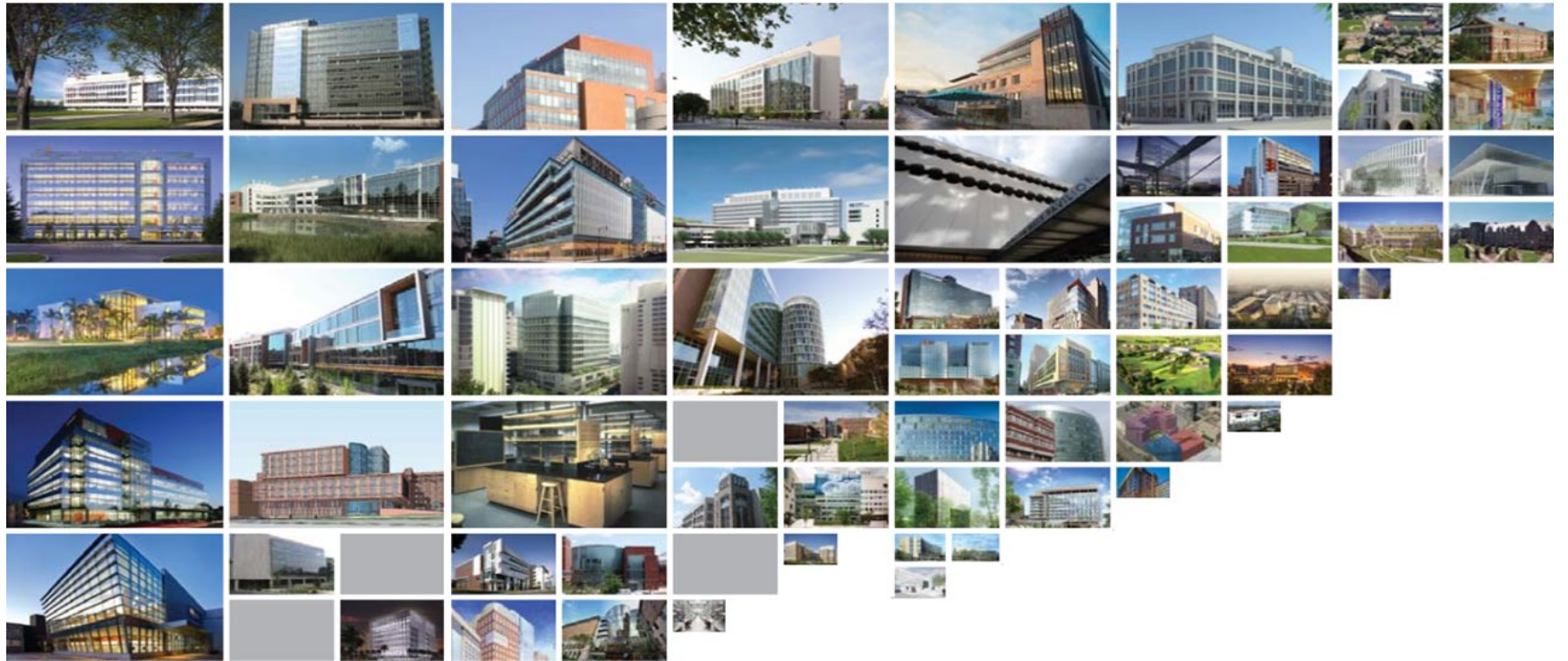

LEGACY



NEW YORK CITY: LOCAL LAW 97

BR+A's commitment to sustainability precedes the creation of LL97

5+ years of experience in ZNE design

80 x 50

80% carbon reduction by 2050

2024-2029 limits will affect the 20% most carbon-intensive buildings

2030-2034 limits will affect the 75% most carbon-intensive buildings



WHY ELECTRIFICATION?

Campuses, cities and countries are targeting carbon neutrality

Net zero codes and existing building energy regulations are going into effect

Clients are asking us ‘how do we cost effectively achieve these goals?’

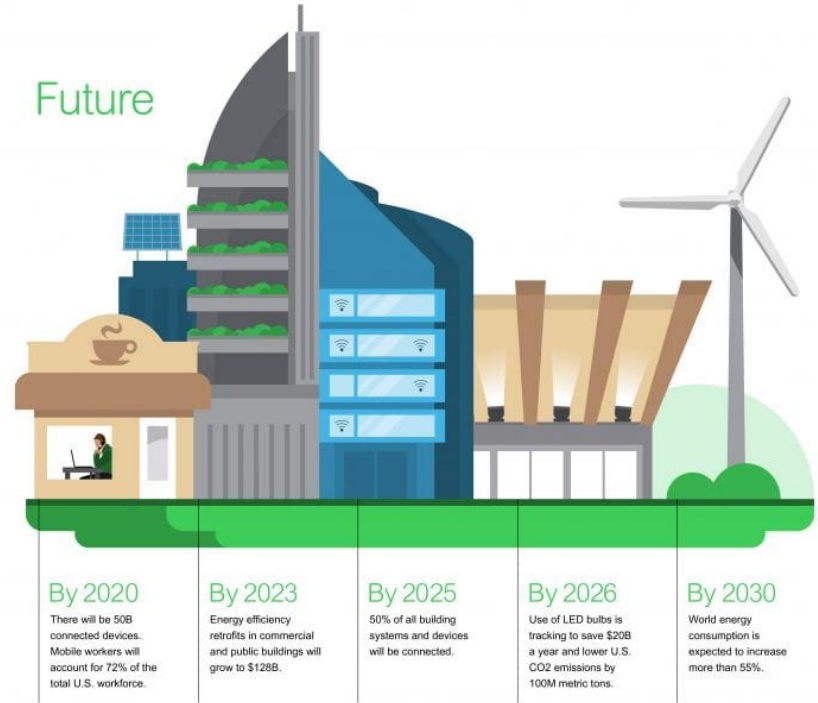

FLEXIBILITY

We offer flexible solutions that adapt to your project and your budget.

Our focus is on the Triple Bottom Line:

Profit: The traditional measure of corporate profit¹

People: Measures how socially responsible an organization has been throughout its operations¹

Planet: How environmentally responsible a firm has been¹

Designs range from least cost buildings to world-class innovations

¹Investopedia; Triple Bottom Line (TBL)



BEST IN CLASS ENGINEERING

13 Offices

40+ Years

400+ Employees

1000+ Successful projects

BR+A is leading the industry, with **millions of square feet of net zero buildings** in operation, construction and design

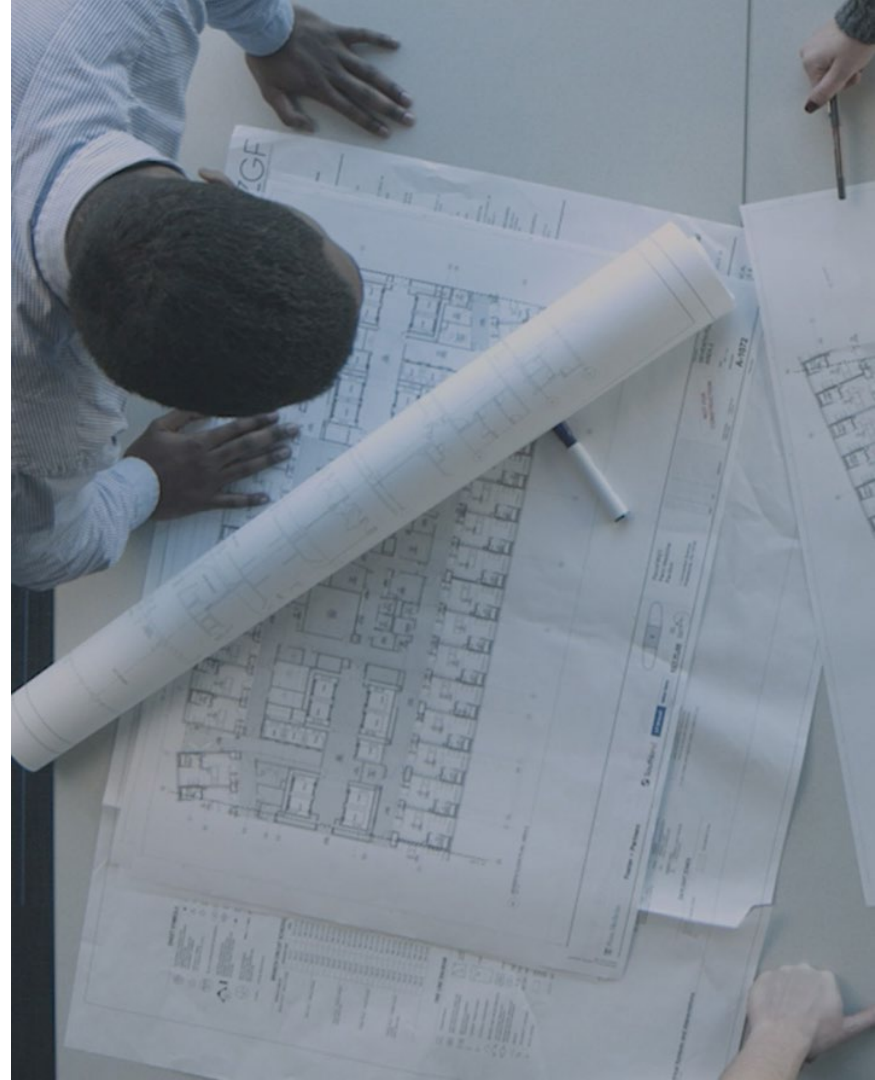



PATH TO ZNE

WHAT IS NET ZERO?

A Net Zero building generates as much renewable energy as it consumes, on an annual basis

There are four metrics to measure energy performance: site, source, cost, and carbon

Four classes of net zero: A, B, C, and D

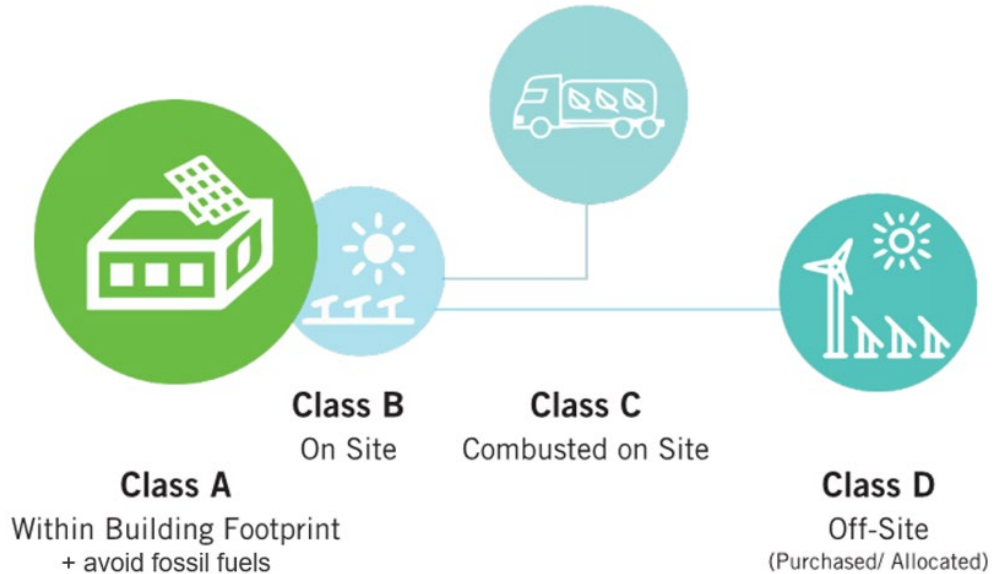

ZNE APPROACH

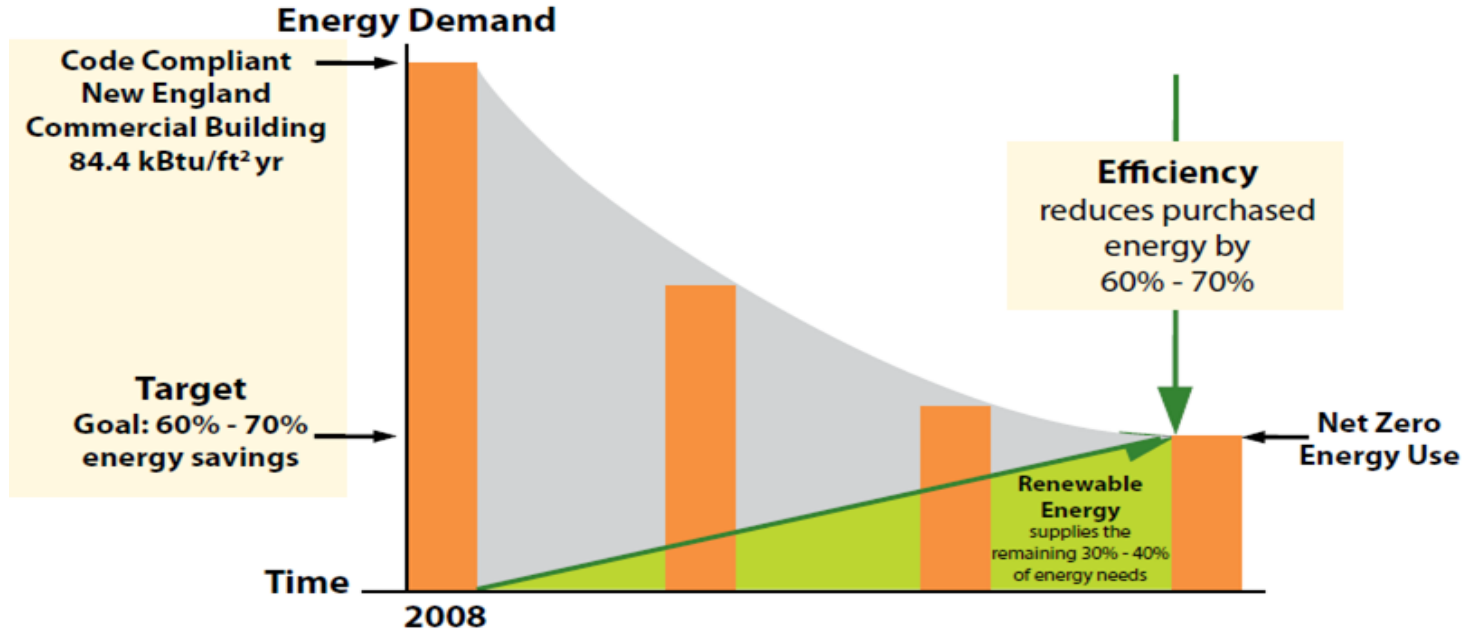

ZNE METRICS

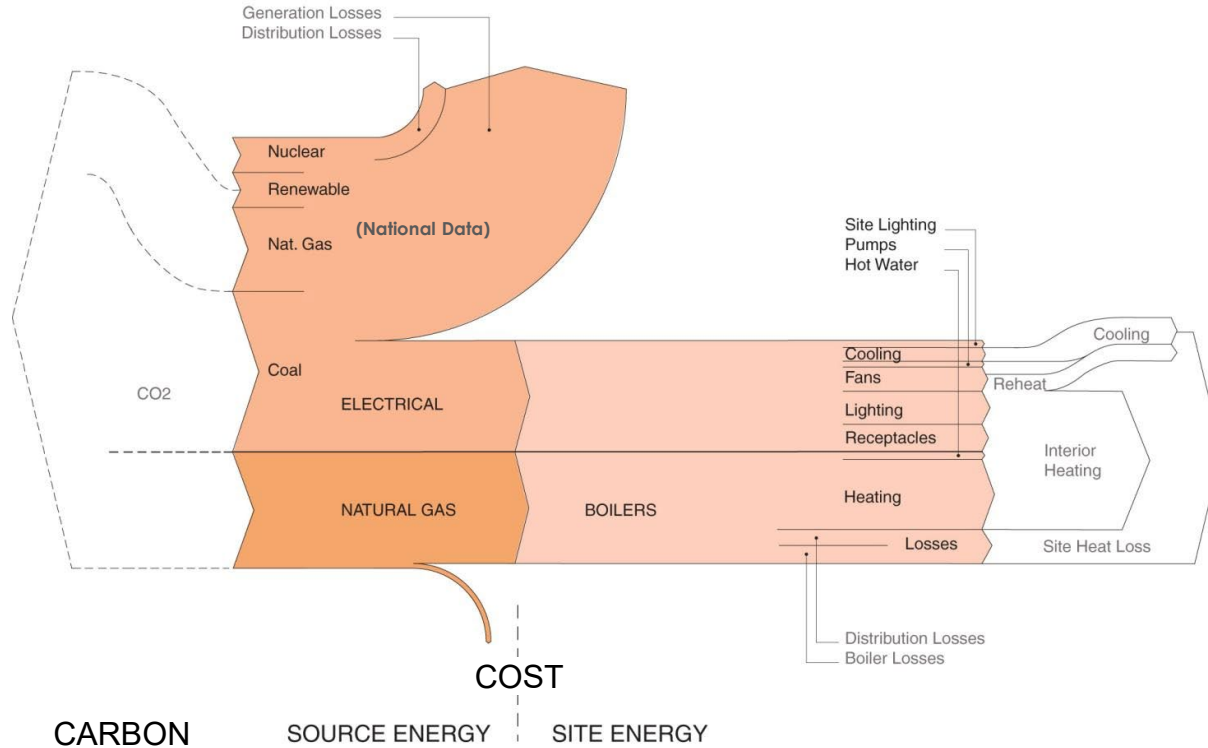

ZNE BUILDINGS AND DISTRICTS

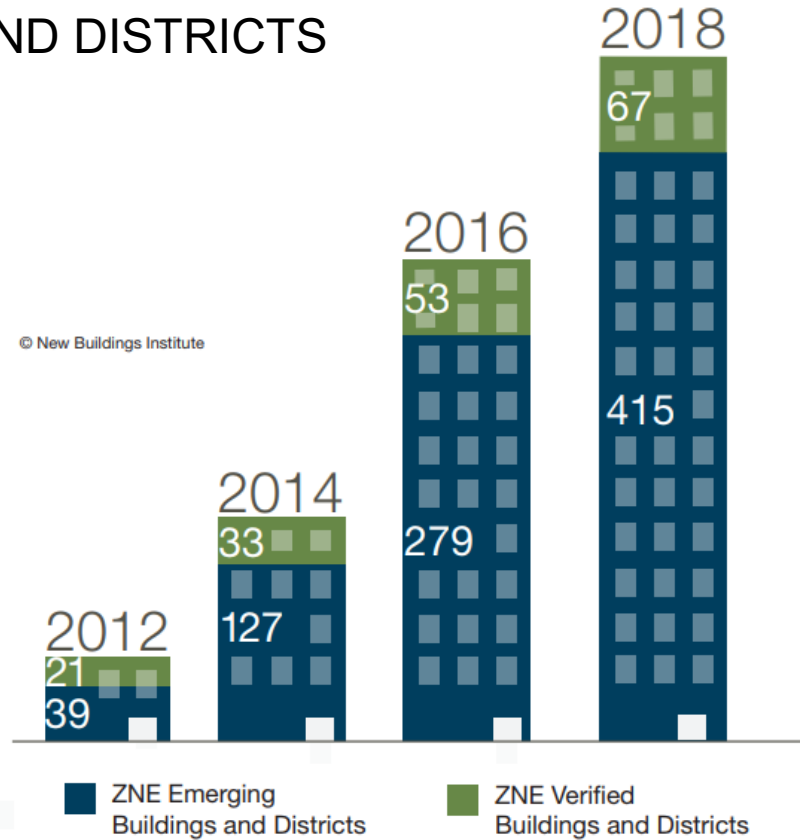

ZNE BUILDINGS BY TYPE

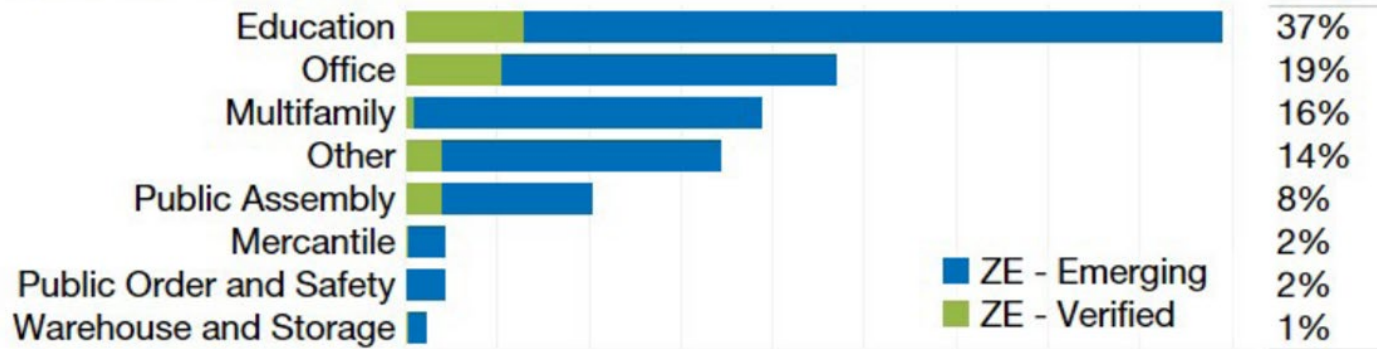

Education Breakdown

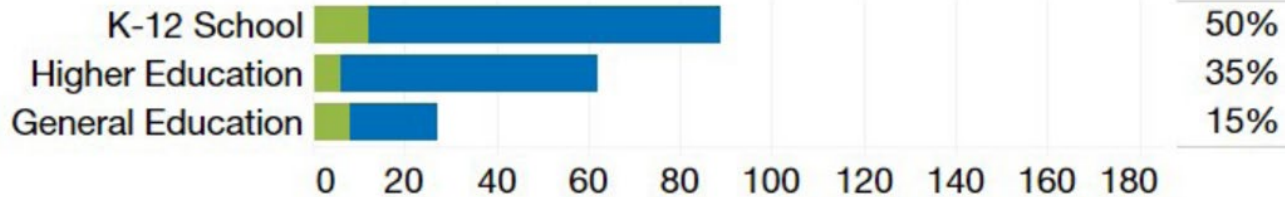

Building Count

© New Buildings Institute

BUILDING SIZE BY ZNE STATUS

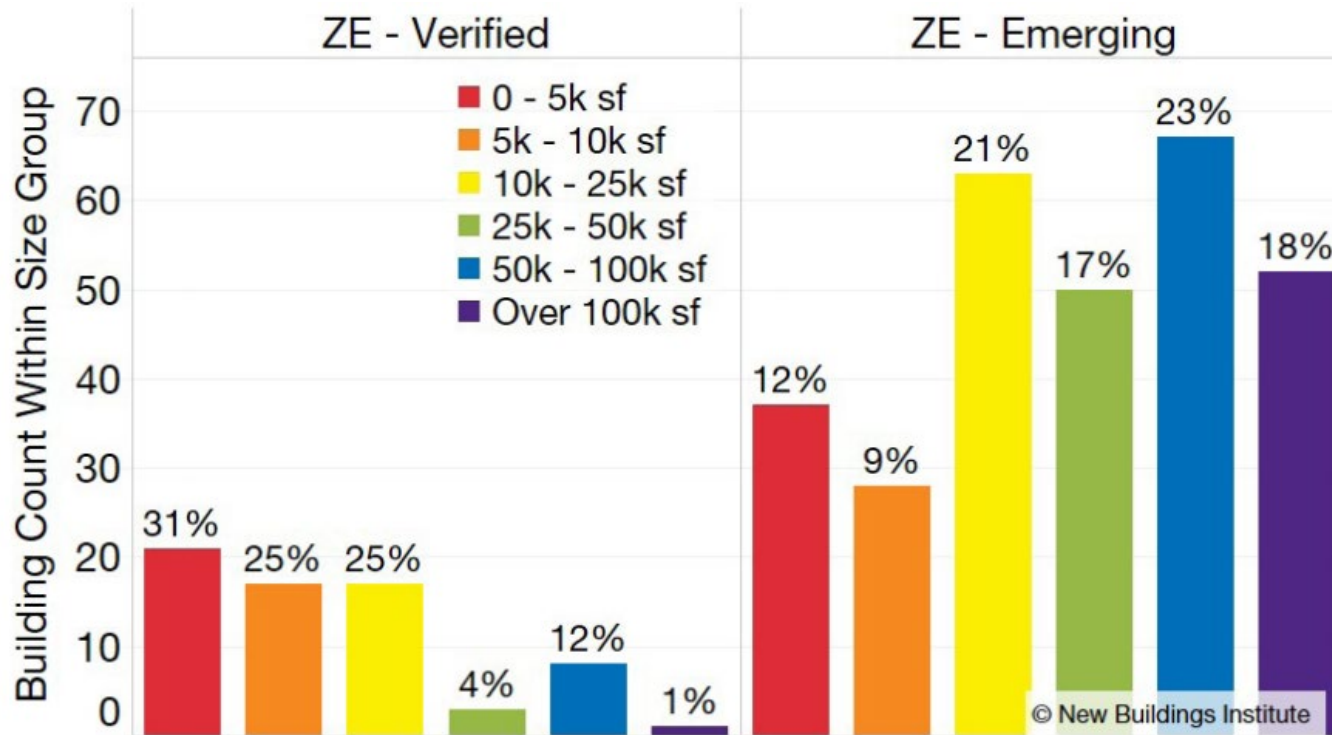

ZNE CODES

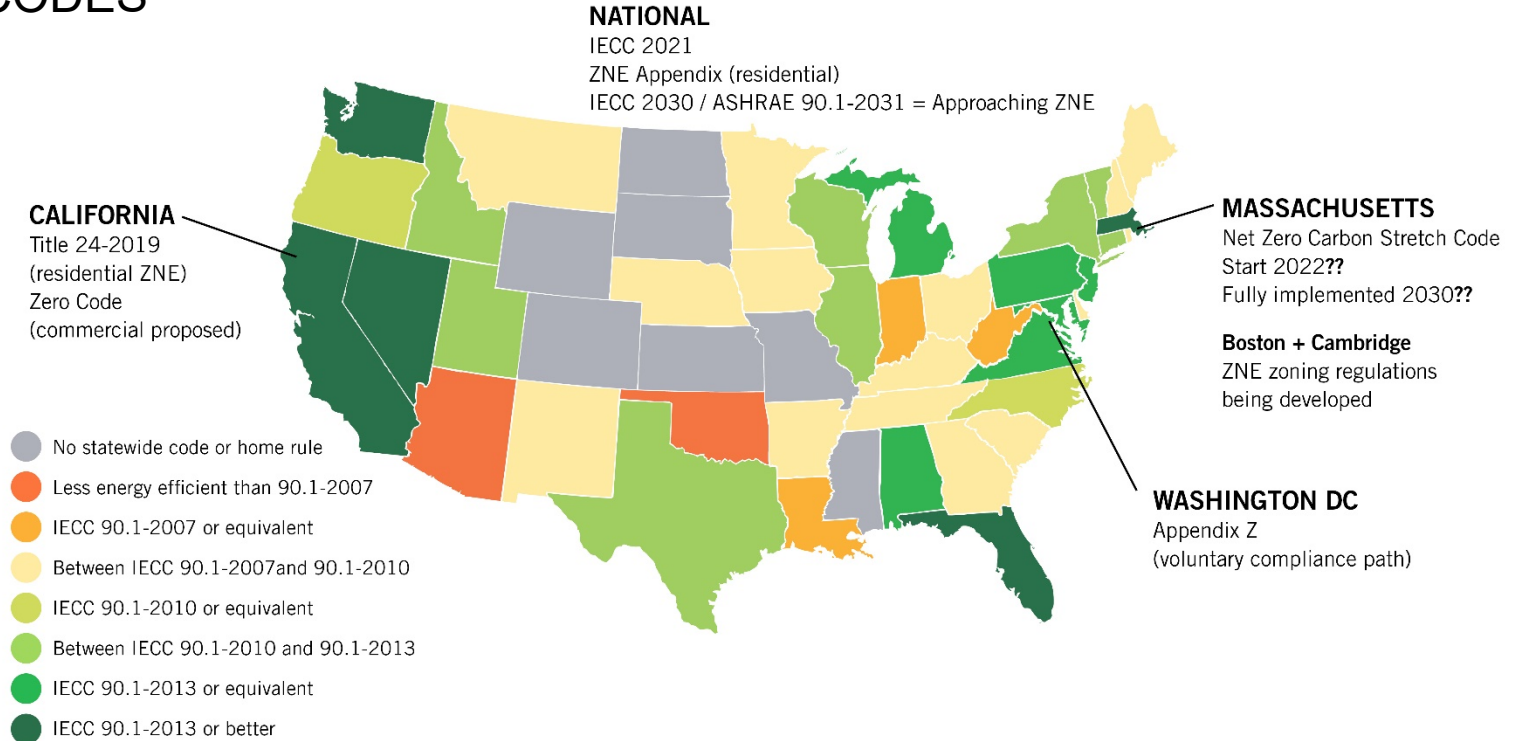

EXISTING BUILDINGS

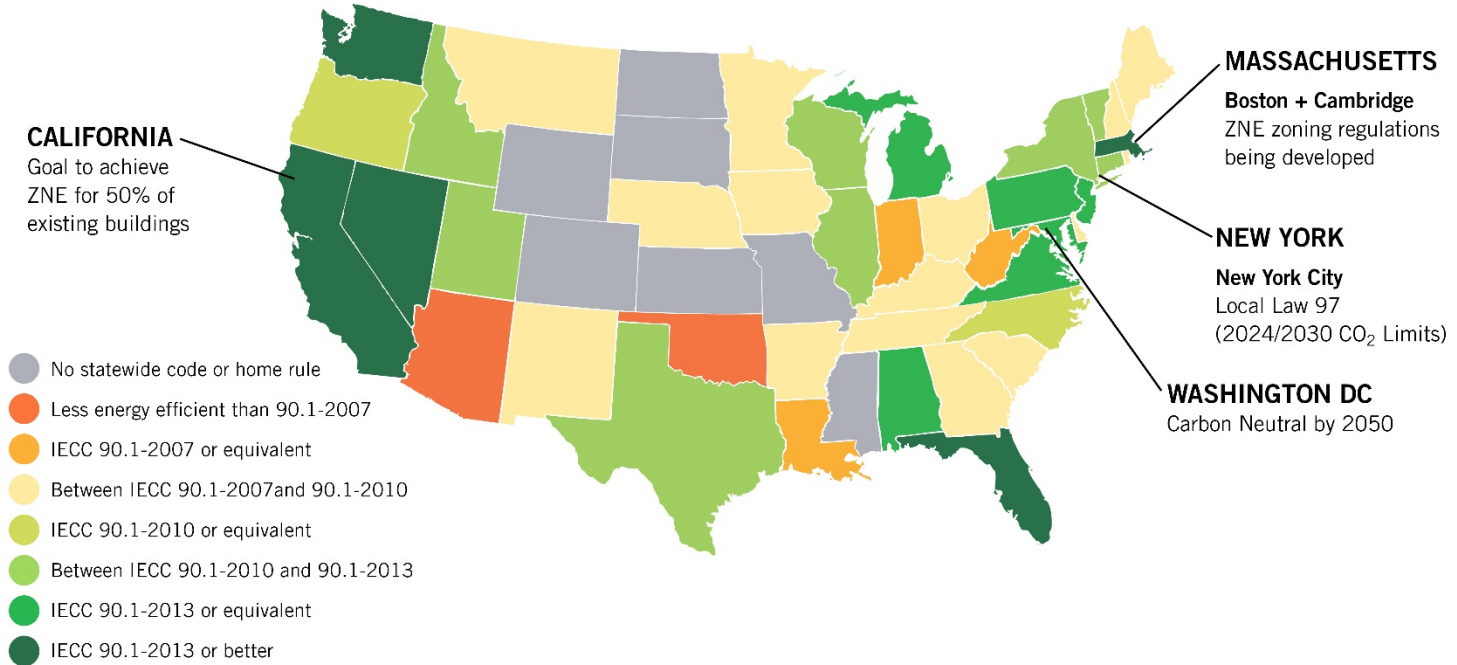

ZNE: S, M, L, XL

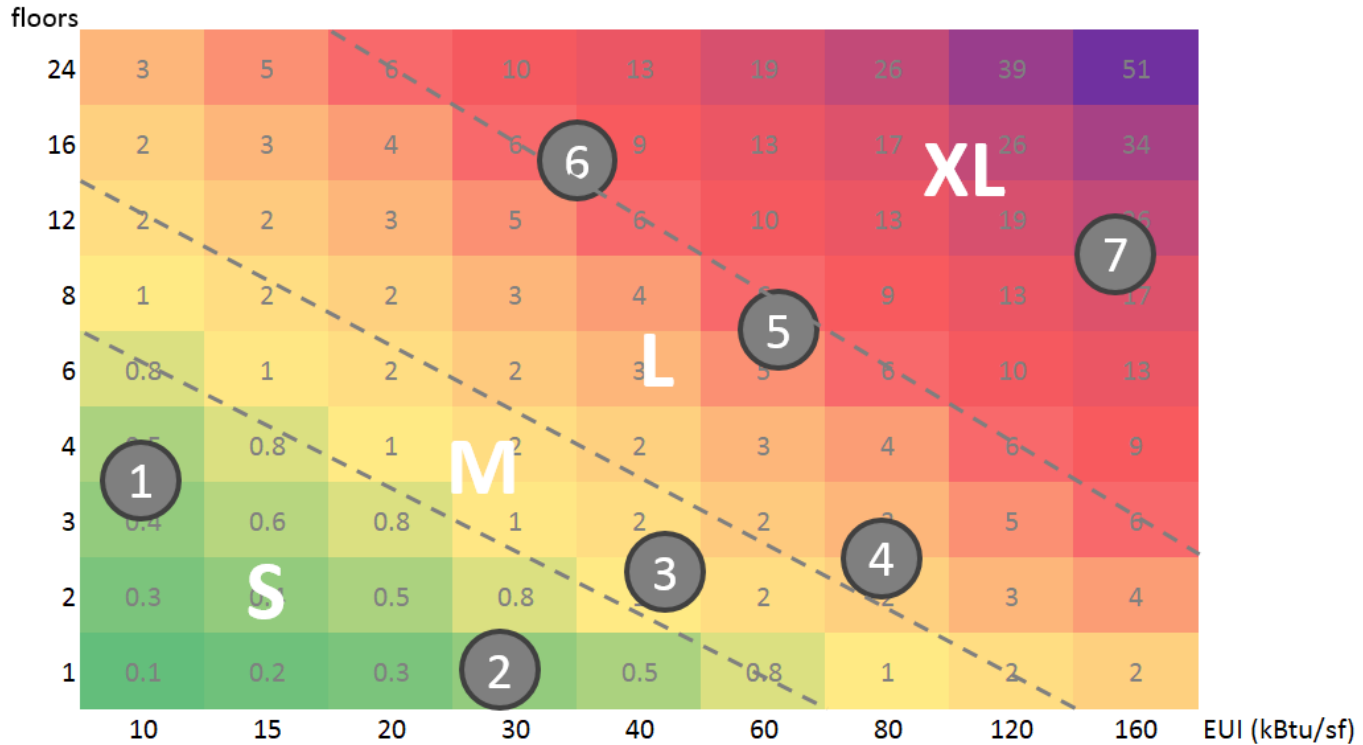

SMALL: Harvard University, ARTLAB

Triple Glazing

Solar Array

VRF Fan Coil Units



MEDIUM: Bristol Community College, John J. Sbrega Health & Science Building

Net Zero

Only 1% Construction Cost Premium

First verified zero net energy lab in the U.S.



HIGH PERFORMANCE

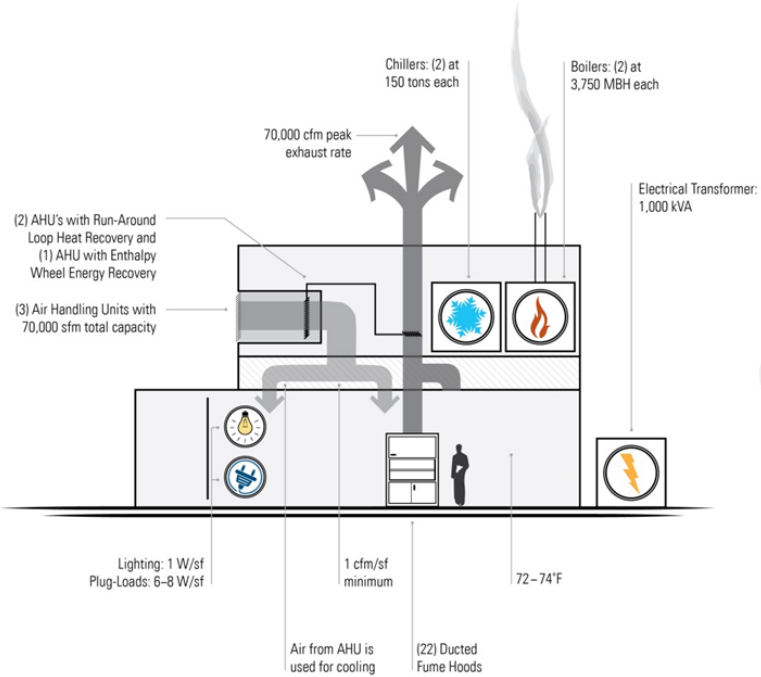

VS

ZERO NET ENERGY

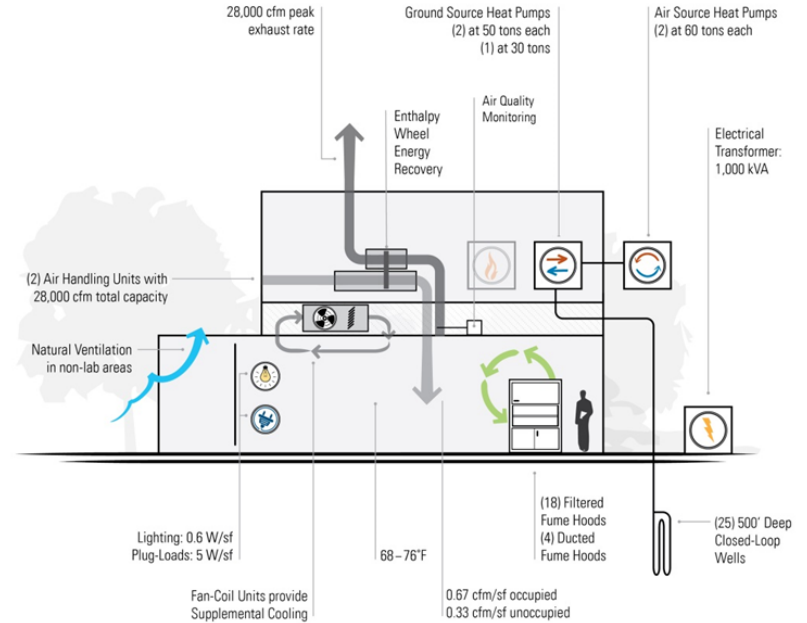



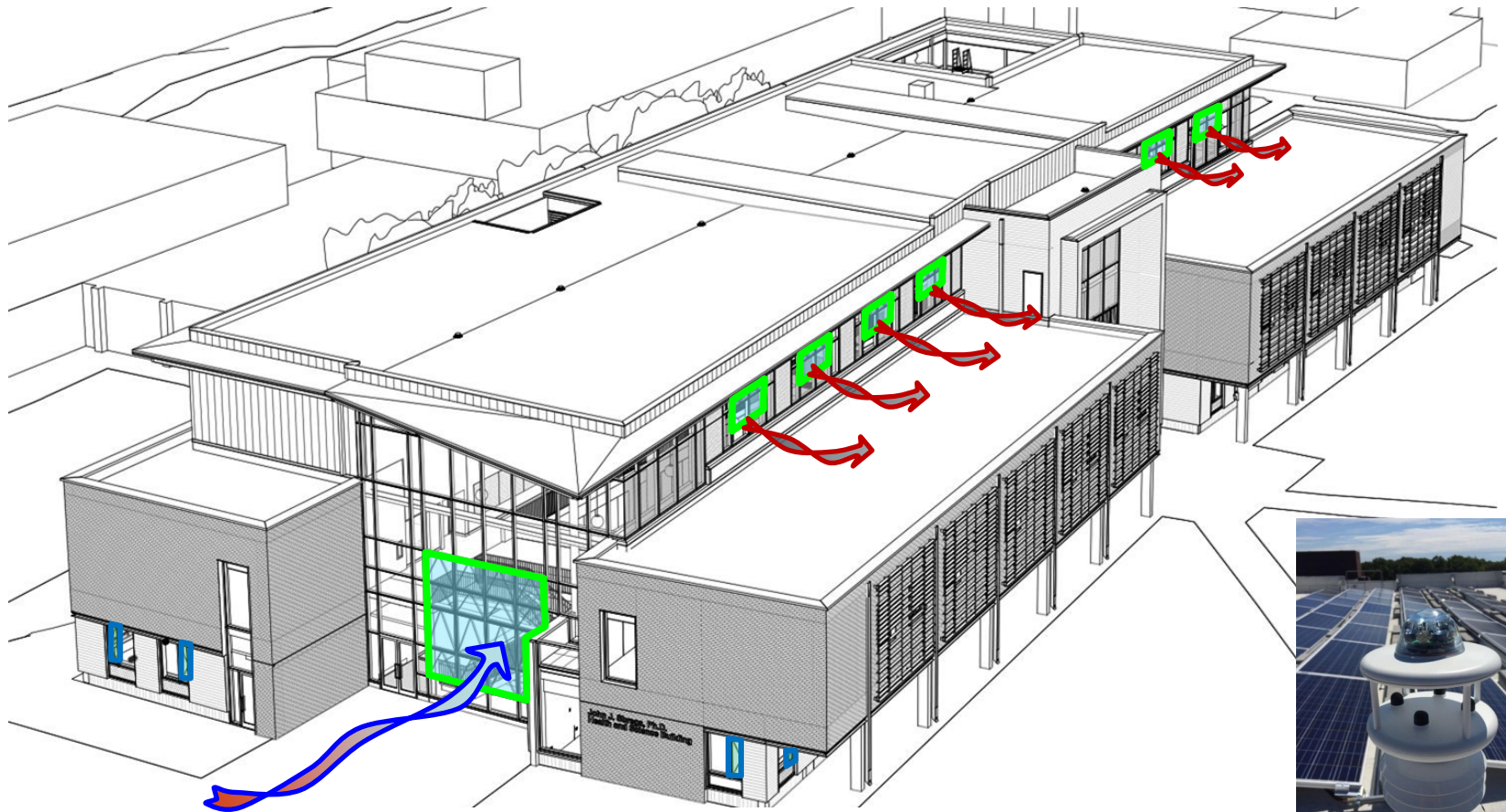

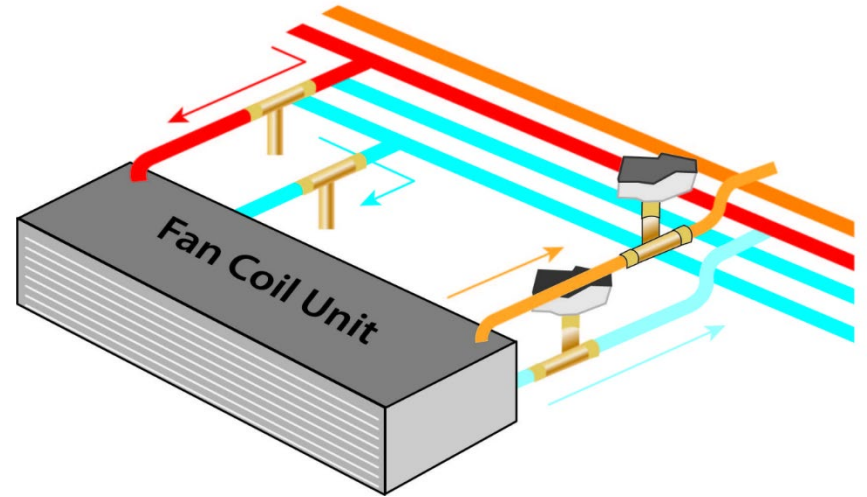
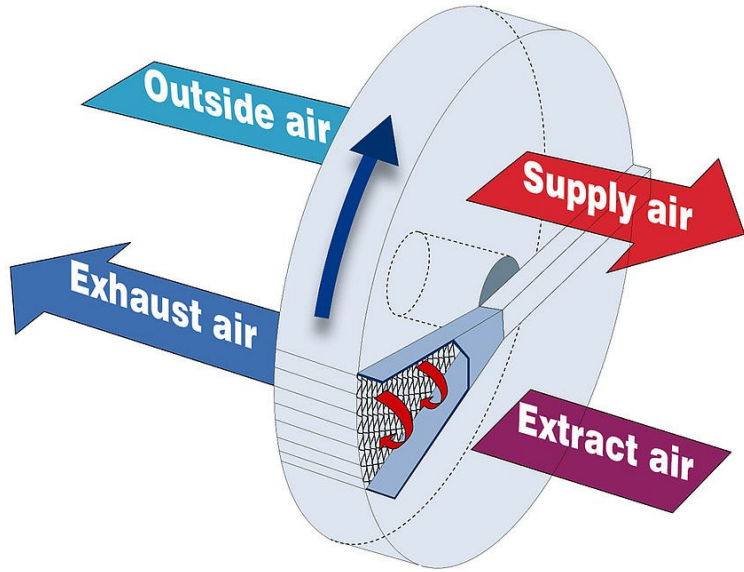

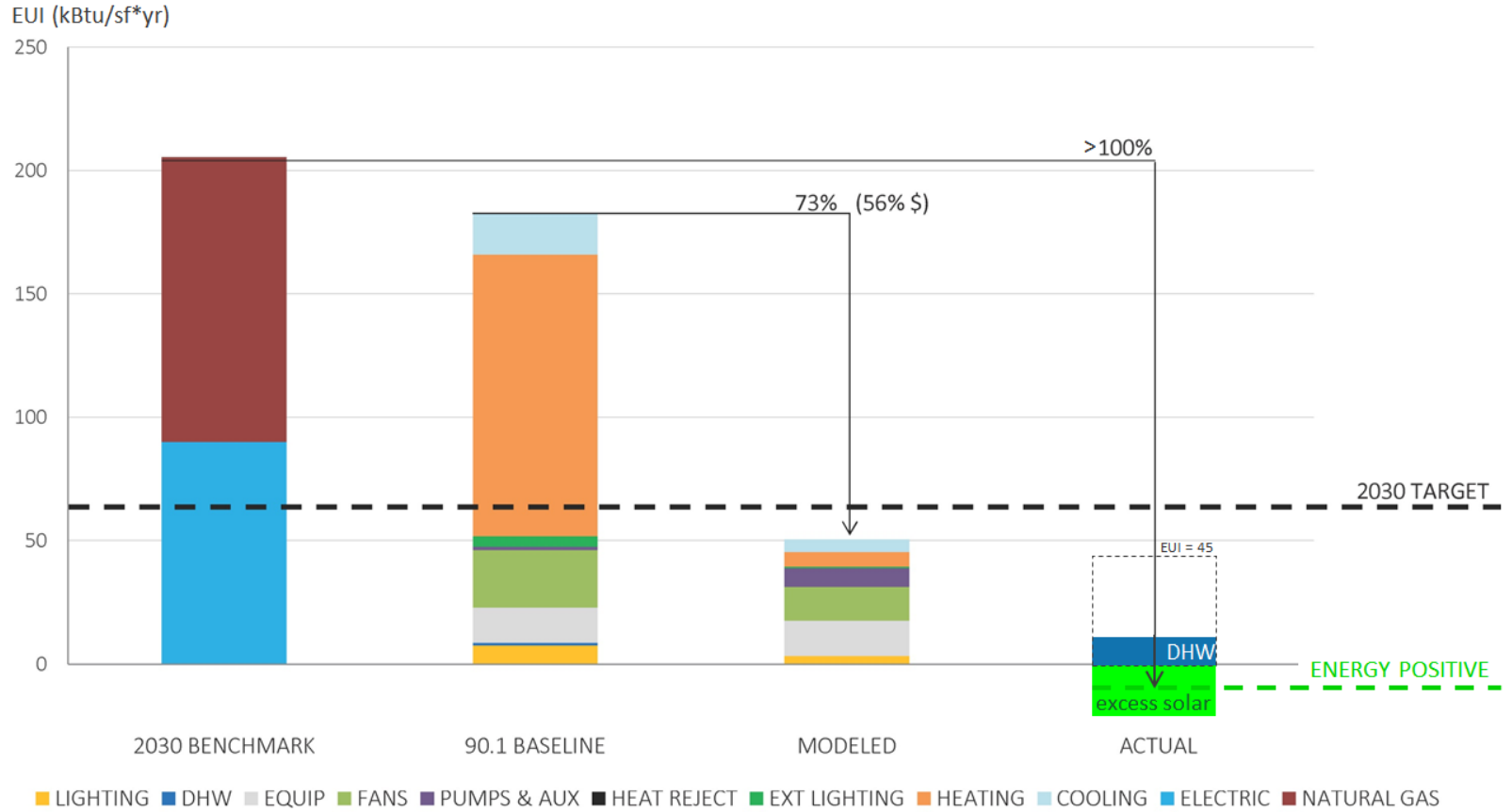

LARGE: Chelsea Soldiers' Home, Community Living Center

250,000 SF Healthcare Facility

Provides housing and care for veterans

145 closed loop geothermal wells 500 ft deep

Triple Glazing

0.5MW Solar Array



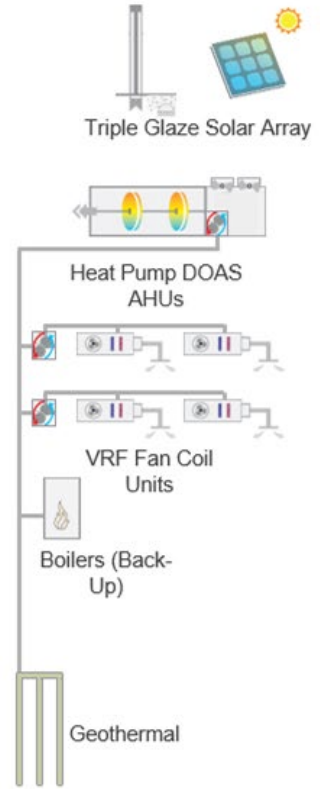
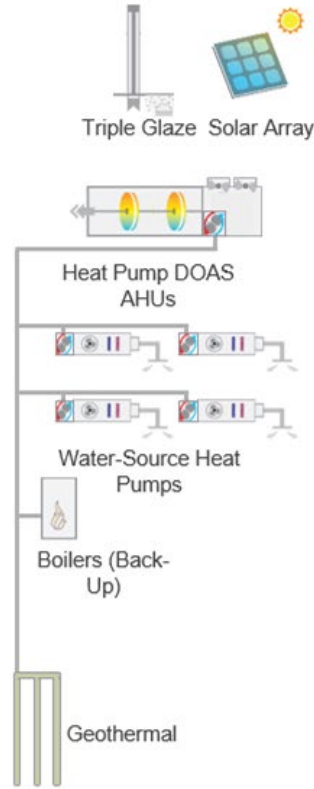
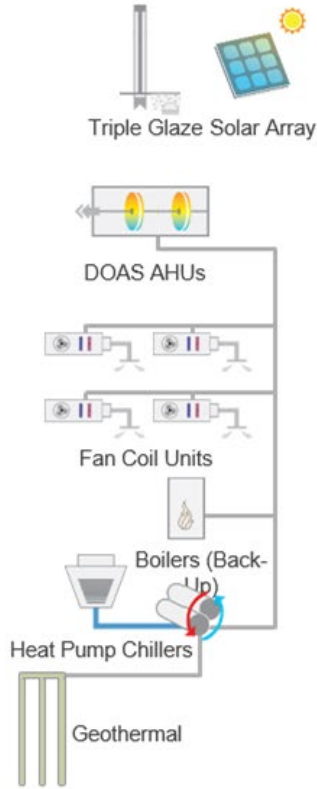
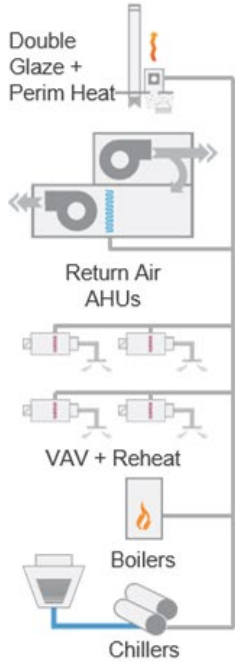

EXTRA LARGE: Boston University, Data Science Center

350,000 SF

Solar Array

DOAS AHUs (Dual Wheel)

Fan Powered Boxes + Chilled Beams

Triple Glazed + Fixed Exterior Shades

Electric Boilers (Peak + Back-up)

Heat Pump VFD Scroll + Screw Chillers w/ Buffer Tanks

Geothermal

100% ELECTRIC

Demonstrated Leadership in Electrification Design



Total Energy Wheel:
 humidity & temperature
 transferred to exhaust
 airstream

Passive Desiccant Wheel:
 humidity transferred to ex-
 haust airstream, temp
 transferred to supply airstream

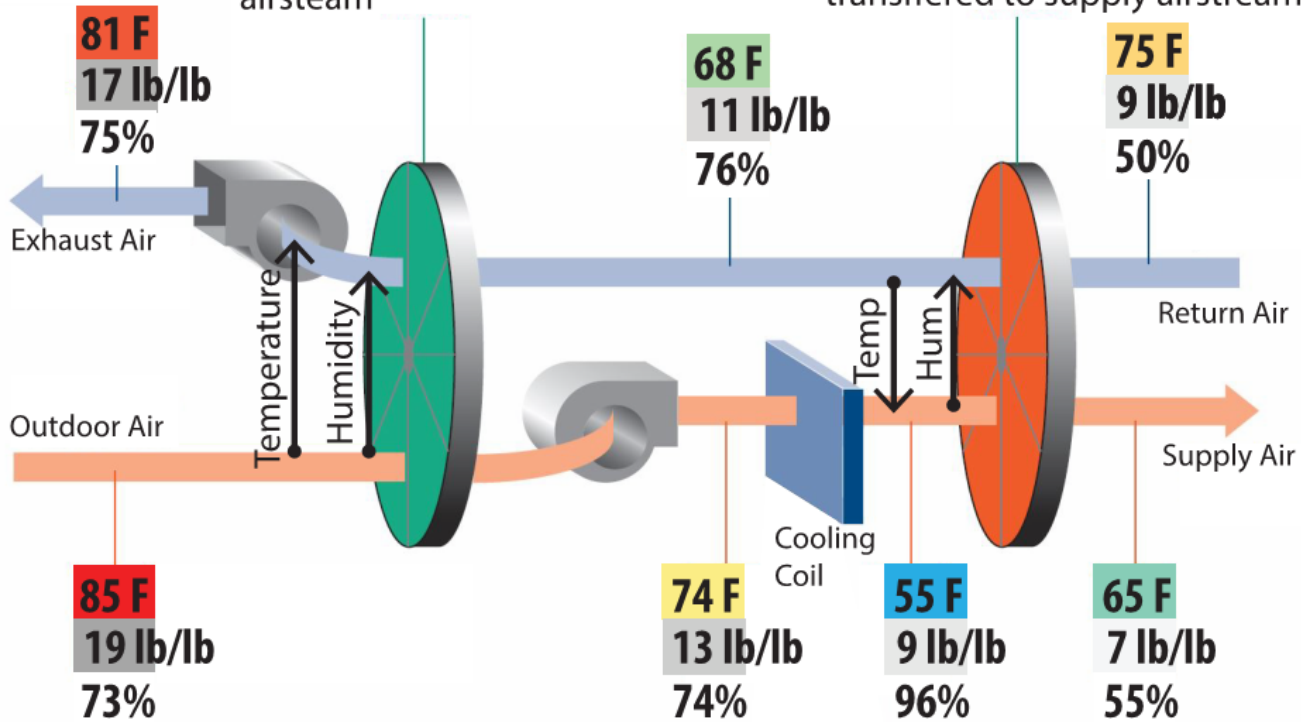

THANK YOU!

Jason Lukes, LEED AP

Associate Principal
646.205.7246
JLukes@brplusa.com

Jacob Knowles, LEED AP

Associate Principal | Director of Sustainable Design
617.925.8376
JKnowles@brplusa.com

Andrew Kozak, PE, AEE Fellow, CEM

Principal | Director of Mechanical Engineering
646.205.7207
Akozak@brplusa.com

105 Madison Ave, 10th Floor
New York, NY, 10016
www.brplusa.com

